

REVISIONS			
REV.	DESCRIPTION	DATE	APPROVED
A	INITIAL RELEASE	02/23/2022	WDIBELLA

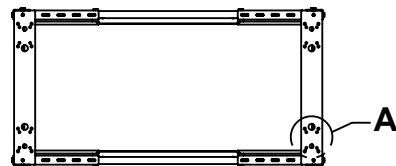
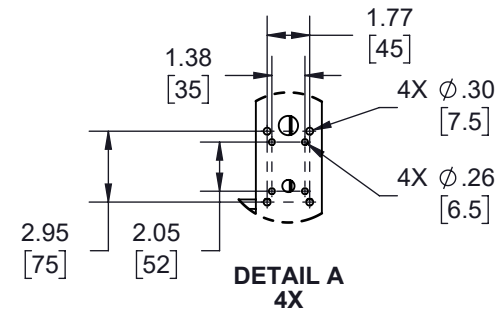
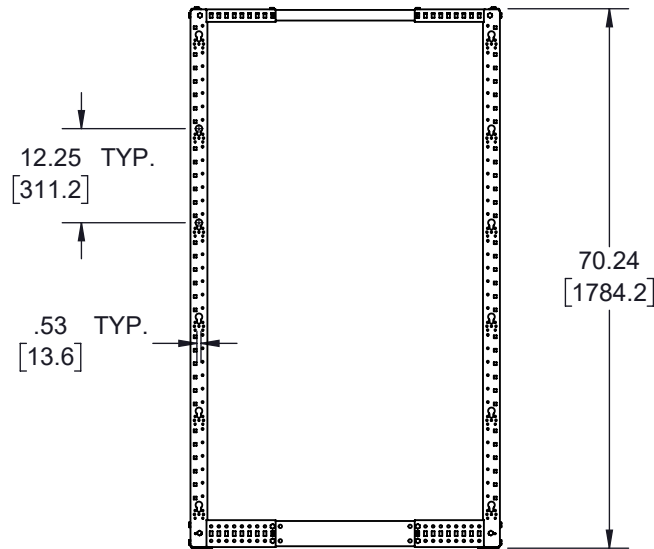
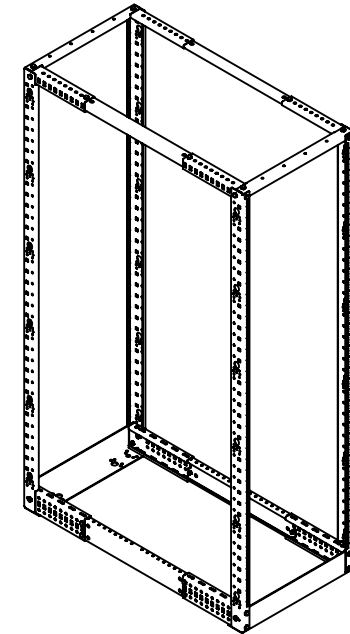
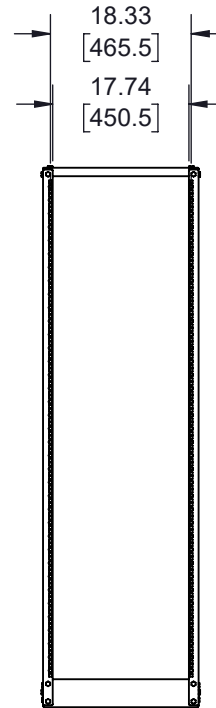
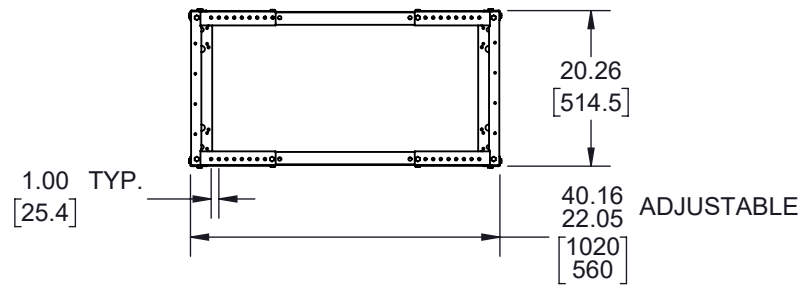

NOTES:

1. MAXIMUM MOUNTING DEPTH: 40.16" [1020mm]
2. MINIMUM MOUNTING DEPTH: 22.05" [560mm]
3. MOUNTING DEPTH ADJUSTABLE IN 1.00" [25.4mm] INCREMENTS.

THESE COMMODITIES, TECHNOLOGY OR SOFTWARE WERE EXPORTED FROM THE UNITED STATES IN ACCORDANCE WITH THE EXPORT ADMINISTRATION REGULATIONS. DIVERSION CONTRARY TO U.S. LAW PROHIBITED.

UNLESS OTHERWISE SPECIFIED LEADING DIMENSIONS ARE INCHES DIMENSIONS IN [] ARE MILLIMETERS

TOLERANCES:
 X = ± 2 [5.08] | FRACTIONS ± 1/32
 .XX = ± 0.02 [.51] | ANGLES ± 1°
 .XXX = ± 0.005 [.13]

CABLE LENGTH (L) TOLERANCES:
 L ≤ 12 [305] = +1 [25] / -0
 12 [305] < L ≤ 60 [1524] = +2 [51] / -0
 60 [1524] < L ≤ 120 [3048] = +4 [102] / -0
 120 [3048] < L ≤ 300 [7620] = +6 [152] / -0
 300 [7620] < L = +5%L / -0

ALL DIMENSIONS SHOWN ARE FOR REFERENCE ONLY.



an INFINIT® brand

859 E. Park Avenue, Libertyville, IL 60048

Phone: 1.800.505.1363

Website: www.navepoint.com

E-mail: sales@navepoint.com

THIRD-ANGLE PROJECTION

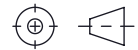

THE INFORMATION AND DESIGN IN THIS DOCUMENT IS THE PROPERTY OF TRANSECTOR, INC. ALL RIGHTS RESERVED.

SHEET 1 OF 1

SCALE N/A

SIZE A	CAGE CODE 7UTA6	DRAWN BY HBAKKE	ITEM NO. 00406965	REV A
-----------	--------------------	--------------------	----------------------	----------