

6

5

4

3

2

1

REVISION					
ZONE	REV	DESCRIPTION	DATE	CHANGED BY	APPROVED
	A	INITIAL RELEASE	04/07/2023	DZINN	GUTTADAURO

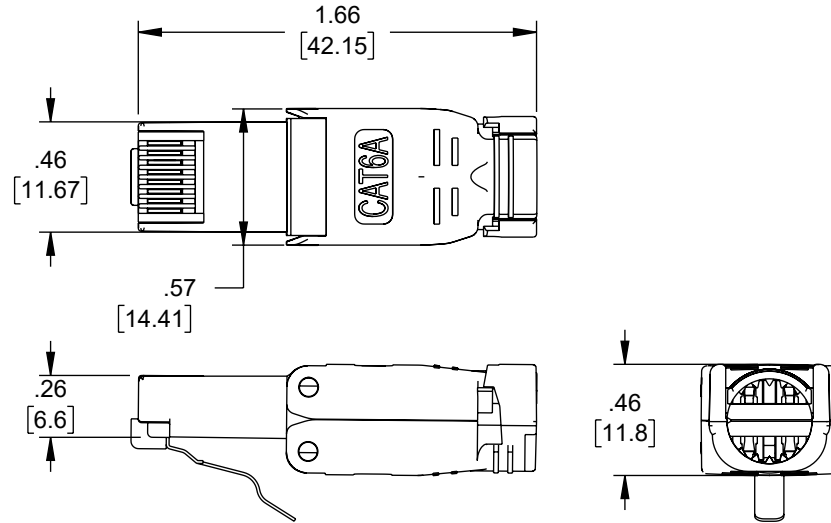
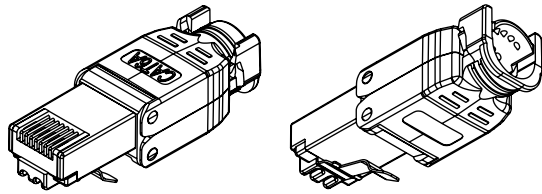

NOTES:

TYPE:

- 1. CAT6A FTP TOOLLESS KEYSTONE JACK.

ELECTRICAL:

- 1. CONTACT RESISTANCE: 20m OHM.
- 2. INSULATION RESISTANCE: ≤500M OHM @100 V DC.
- 3. WITHSTAND VOLTAGE: DC1000V AC700V RMS 60Hz, 1MIN.
- 4. CAT6A PERMANENT LINK: CONFORM TO ANSI/TIA/EIA 568B. 2-10.

ENVIRONMENTAL:

- 1. STORAGE: -40 / +70.
- 2. OPERATION: -10 / +60.

MECHANICAL:

- 1. METAL MATERIAL: ZINC ALLOY.
- 2. IDC MATERIAL: NEW PC, EXCEPT 22-24 AWG SOLID WIRE.
- 3. TERMINAL: PHOSPHOR BRONZE, TIN GOLD 3 MICRON.
- 4. RJ45 CONTACT LIFE: 750 TIMES MIN.
- 5. IDC LIFE: 250 TIMES MIN.

ALL DIMENSIONS FOR REFERENCE ONLY.

REGULATORY COMPLIANCE:

EU RoHS DIRECTIVE (MOST RECENT RELEASED VERSION)

THE INFORMATION CONTAINED IN THIS DRAWING IS THE SOLE PROPERTY OF INFINITE ELECTRONICS, INC. ANY REPRODUCTION IN PART OR WHOLE WITHOUT THE WRITTEN PERMISSION OF INFINITE ELECTRONICS, INC. IS PROHIBITED. THESE COMMODITIES, TECHNOLOGY OR SOFTWARE WERE EXPORTED FROM THE UNITED STATES IN ACCORDANCE WITH THE EXPORT ADMINISTRATION REGULATIONS. DIVERSION CONTRARY TO U.S. LAW PROHIBITED.

UNLESS OTHERWISE SPECIFIED LEADING DIMENSIONS ARE INCHES DIMENSIONS IN [ ] ARE MILLIMETERS

TOLERANCES:	
.X = ±.2 [5]	FRACTIONS ± 1/32
.XX = ±.02 [.5]	ANGLES ± 1°
.XXX = ±.005 [.13]	

CABLE LENGTH TOLERANCES:	
>12 [305]	= +1 [25] / -0
>12 [305] ≤ 60 [1524]	= +2 [51] / -0
>60 [1524] ≤ 120 [3048]	= +4 [102] / -0
>120 [3048] ≤ 300 [7620]	= +6 [152] / -0
>300 [7620]	= +5% / -0

ALL DIMENSIONS ARE FOR REFERENCE ONLY AND SUBJECT TO CHANGE WITHOUT NOTICE.



an INFINIT® brand  
 Website: www.NavePoint.com  
 Phone: 1.800.505.1363

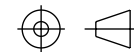

INTERPRET ALL DIMENSIONS AND TOLERANCES PER ASME Y14.5

SCALE	SHEET
NONE	1 OF 1

DESCRIPTION			
CAT6A RJ45 SHIELDED TOOLLESS PLUG WITH METAL BATCH, 30 PACK			
SIZE	CAGE CODE	DRAWN BY	ITEM NO.
A	7UTA6	DZINN	00407203
REV			A

6

5

4

3

2

1